

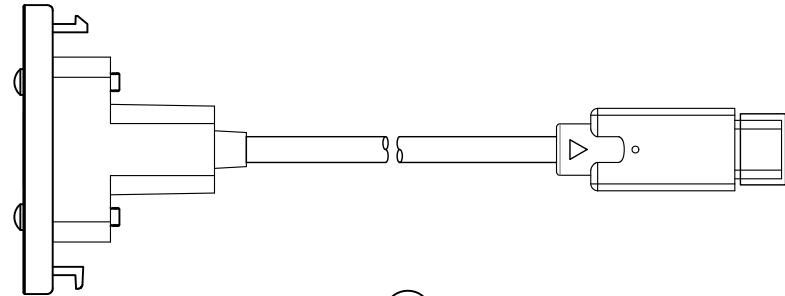

①



②

Ltemref		Quantity	Title/Name, designation, material, dimension etc		Article NO./Reference		
②	20-0017-3	1	USB3.2 TYPE M/M		20-0017	1	Sheet 1/3
①	20-0017-1/2	1	USB3.2 TYPE M/F+PANEL		20-0017	1	Sheet 1/3
NO.	MATERIAL		DESCRIPTION		QTY.	UNIT	
					Designed by FLY Checkde by HELEN Approved by - date 2025.09.29 File name Date 2025.09.29 Scale FREE ANGLE:  UNIT:MM	20-0017	Edition 1 Sheet 1/3

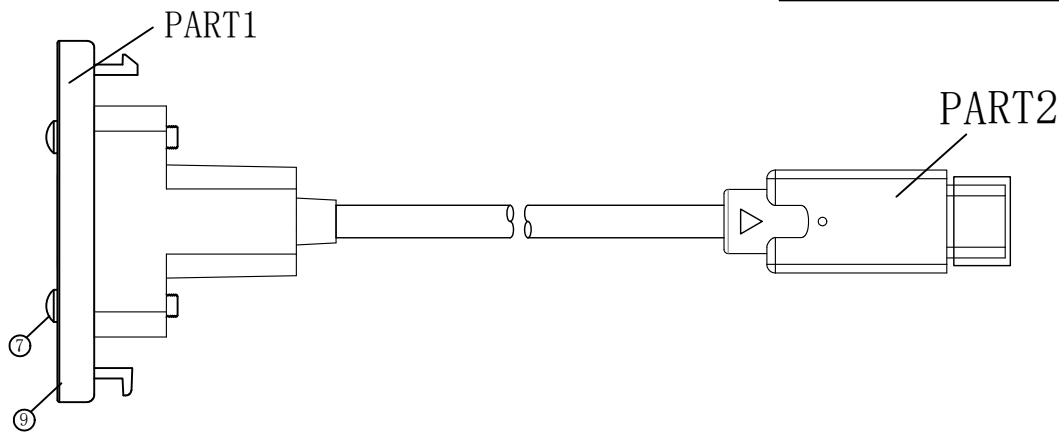
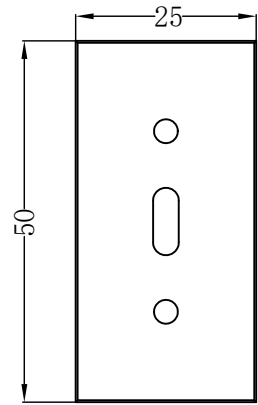

- A. Electronic Tests:
1. Open/Short/Intermittence: 100%
  2. Hi-Pot: AC 150V 0.01S 1mA
  3. Insulation Resistance: DC 300V 0.01S 10MΩ Min
  4. Conductive Resistance: 2Ω Max
- B. Functional Test:
- The set supports 4K@60Hz video resolution
- C. Face plate color:RAL9003

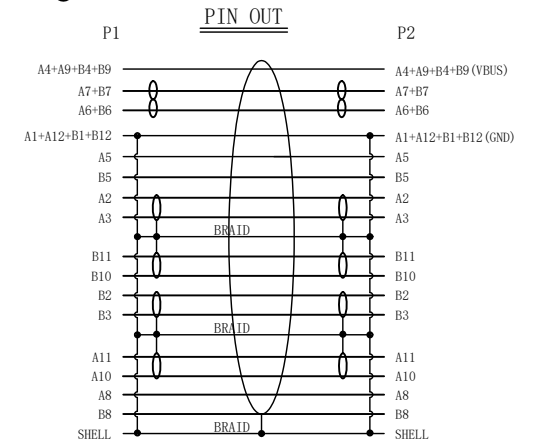
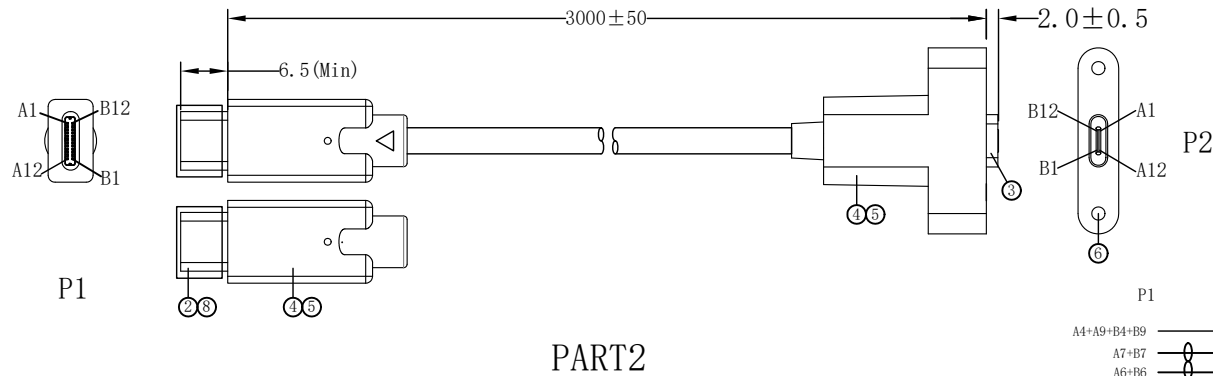
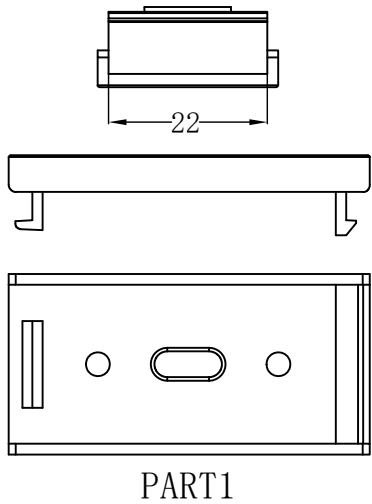

⑨	PANEL	ABS PANEL FOR HDMI AF, 50*25mm, Color:RAL9003	1	PCS
⑧	DUST CAP	TYPE C MALE DUST COVER	1	PCS
⑦	PHILIPS SCREW	PHILLIPS SCREW, #4-40, NI PLATED, L=15MM	2	PCS
⑥	EMBEDDED NUT	PEM NUT, #4-40, NI PLATED, L=10MM	2	PCS
⑤	MOLDING	45P BLACK PVC		G
④	MOLDING	LDPE MG70		G
③	CONNECTOR	TYPE C FEMALE, GOLD PLATED PIN, NICKEL PLATED SHELL+TINPLATE SHIELDING SHELL	1	PCS
②	CONNECTOR	TYPE C MALE, GOLD PLATED PIN, NICKEL PLATED SHELL+TINPLATE SHIELDING SHELL	1	PCS
①	CABLE	[1/0. 22B*1P+D(1/0. 2B) AL+HM]*4C +1/0. 2B*1P+1/0. 20B*4C+7/0. 20B*2C+F+D(41/0. 08T) +AB(16/5/0. 08T), BLACK PVC JACKET OD:4. 8±0. 2MM	3000	MM
NO.	MATERIAL	DESCRIPTION	QTY.	UNIT

Ltemref	Quantity	Title/Name, designation, material, dimension etc			Article NO./Reference		
Designed by FLY	Checkde by HELEN	Approved by - date 2025. 09. 28	File name	Date 2025. 09. 29	Scale FREE		
ANGLE:				USB3. 2 TYPE M/F+PANEL			
UNIT:MM				20-0017-1/2	Edition 1	Sheet 2/3	

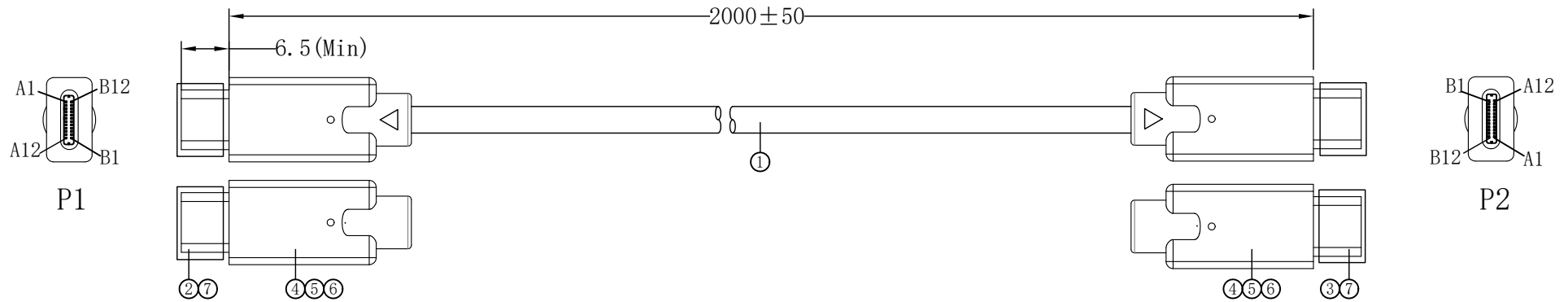

A. Electronic Tests:

1. Open/Short/Intermittence: 100%
2. Hi-Pot: AC 150V 0.01S 1mA
3. Insulation Resistance: DC 300V 0.01S 10MΩ Min
4. Conductive Resistance: 2Ω Max

B. Functional Test:

1. USB4 GEN2: (READ) 1600MB/S (min), (WRITE) 1400MB/S (min)
2. Support PD3.1 48V5A 240W
3. The set supports 4K@60Hz video resolution

C. E\_mark: Gen2x2 20G 240W 2M

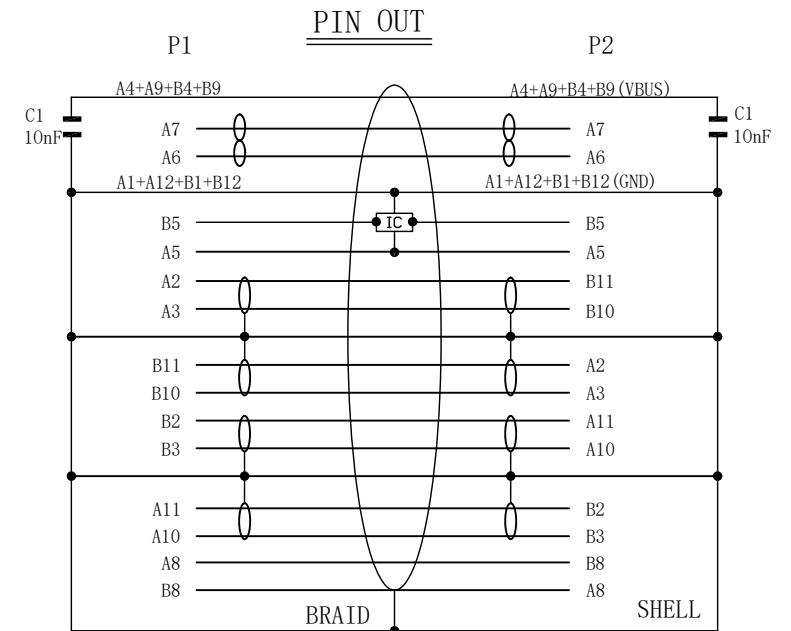

⑦	DUST COVER	TYPE C MALE DUST COVER	2	PCS
⑥	COPPR FOIL	DOUBLE SIDED CONDUCTIVE COPPER FOIL 5MM*30MM	2	PCS
⑤	MOLDED	45P BLACK PVC		G
④	MOLDED	LDPE		G
③	CONNECTOR 2	TYPE C MALE, GOLD PLATED PIN, NICKEL PLATED SHELL+E_MARK CHIP+TINPLATE SHIELDING SHELL	1	PCS
②	CONNECTOR 1	TYPE C MALE, GOLD PLATED PIN, NICKEL PLATED SHELL+TINPLATE SHIELDING SHELL	1	PCS
①	CABLE	[1/0. 22B*1P+D(1/0. 2B)AL+HM]*4C +1/0. 2B*1P+1/0. 20B*4C+7/0. 20B*2C+F+D(41/0. 08T)+AB(16/5/0. 08T), BLACK PVC JACKET OD:4. 8±0. 2MM	2000	MM
NO.	MATERIAL	DESCRIPTION	QTY.	UNIT

Ltemref	Quantity	Title/Name, designation, material, dimension etc			Article NO./Reference	
Designed by FLY	Checkde by HELEN	Approved by - date 2025. 09. 26	File name	Date 2025. 09. 26	Scale FREE	
ANGLE:				USB3. 2 TYPE M/M		
UNIT:MM				20-0017-3	Edition 1	Sheet 3/3